

ALEKO® Indoor Sauna

www.AlekoProducts.com

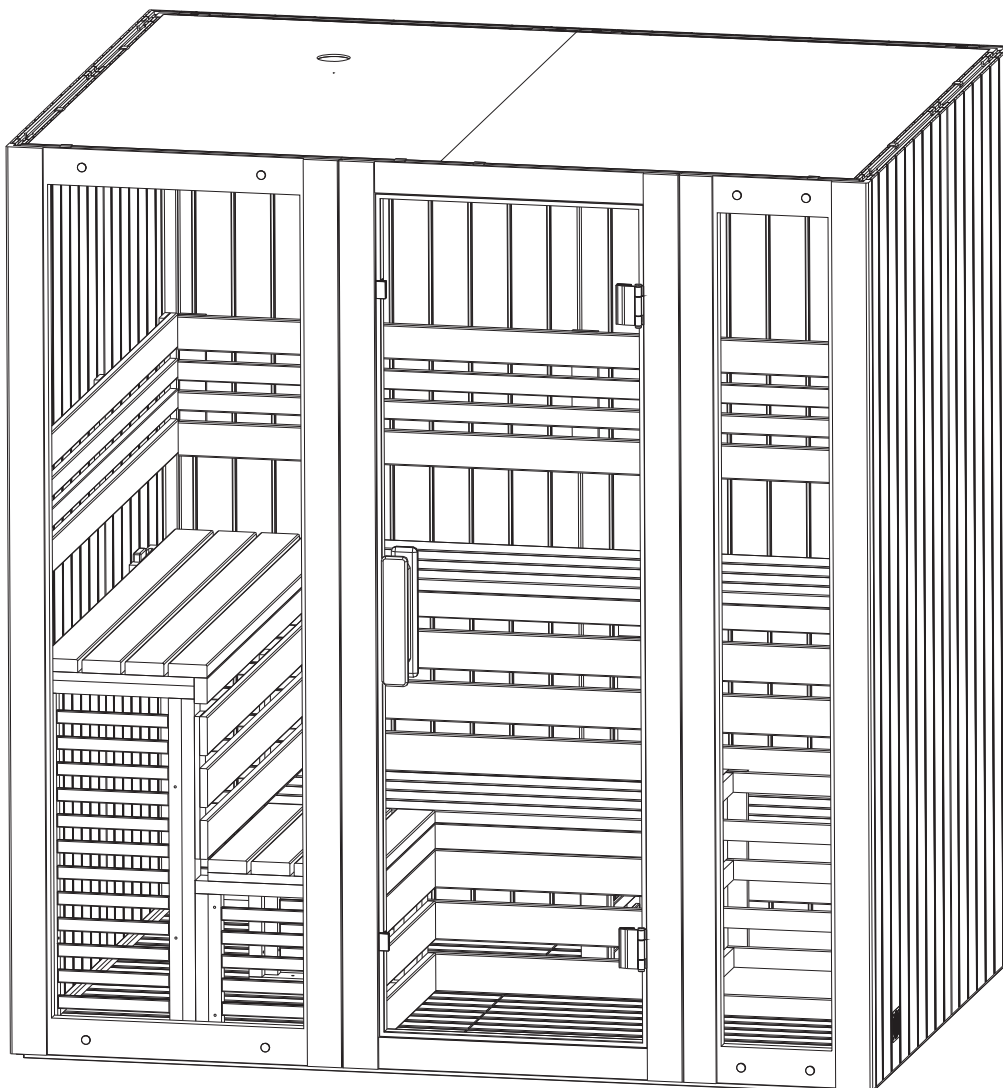

User's Manua for 6-Person Sauna

Introduction:

Instructions before assembly :

- (1).At least two people are required to assemble the sauna.
- (2).Mounting location: check whether the ground or platform is horizontal, and slight slope will not affect the mounting and use of sauna, but if the slope is evident, a shim is needed to keep the sauna level.
- (3).All screw heads to mount sauna must be completely in wood to avoid burns during use. If you want to mount accessories provided by other companies to the sauna, try to avoid metal accessories, or insulate them.
- (4).Please find qualified electricians to install the electrical elements in sauna.

1. Tools we provided



2. Tools you need to prepare

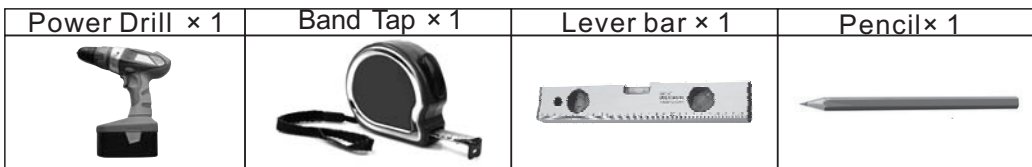

3. Screw and accessories list

Basic configuration				
No.	Name	Dimension	Unit	Model No.
				TC6/TH6
1	Sauna heater (recommended)		Pc	6kw/1
2	4L bucket		Pc	1
3	Sauna stone		kg	20
4	Thermometer and hygrometer		Pc	1
5	Ladle		Pc	1
6	Glue		Pcs	2

The main wooden parts

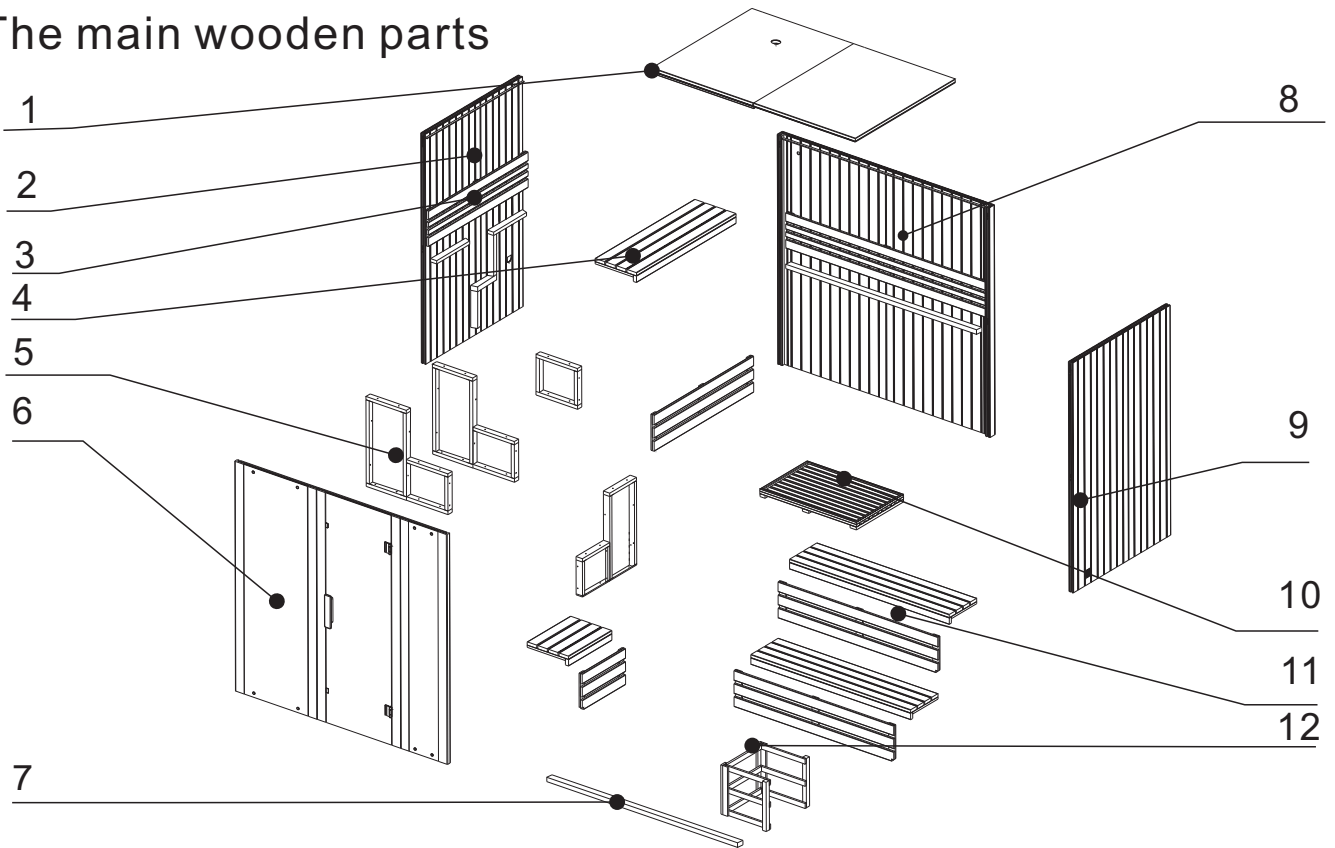

S/N	Name	QTY
1	Top panel	2
2	Left wall	1
3	Backrest	2
4	Bench panel	4
5	Bench feet	4
6	Front wall	1
7	Bottom connection bar	1

S/N	Name	QTY
8	Back wall	2
9	Right wall	1
10	Bottom board	1
11	Stool decorating board	4
12	Heater fence	1

Sauna Room Assembly

- 1、 Back wall installation4
- 2、 Front wall installation..... 5
- 3、 Top Panel installation..... 6
- 4、 Bottom board installation.....6
- 5、 Bench and other accessories installation.....7
- 6、 Sauna Heater guard installation.....8
- 7、 Uses and recommendations.....9



1. Back wall installation

1-1: Back wall components

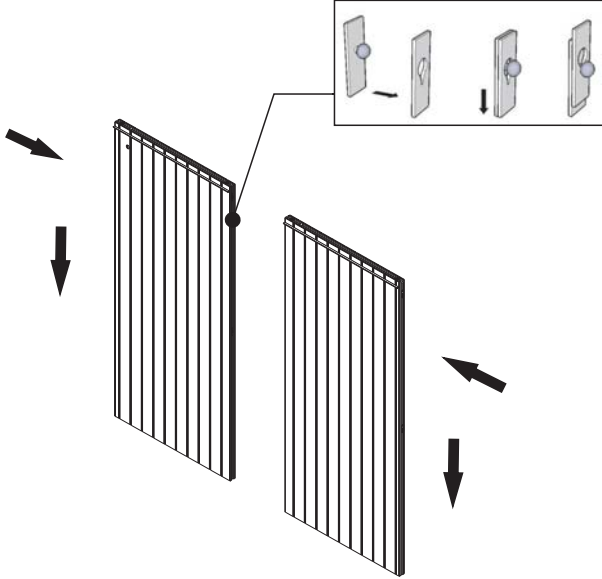

Hold up the back wall board and joint two boards as shown in the arrow.

1-2: Hold up the left and right walls, making it 90° connecting vertically with the back wall.

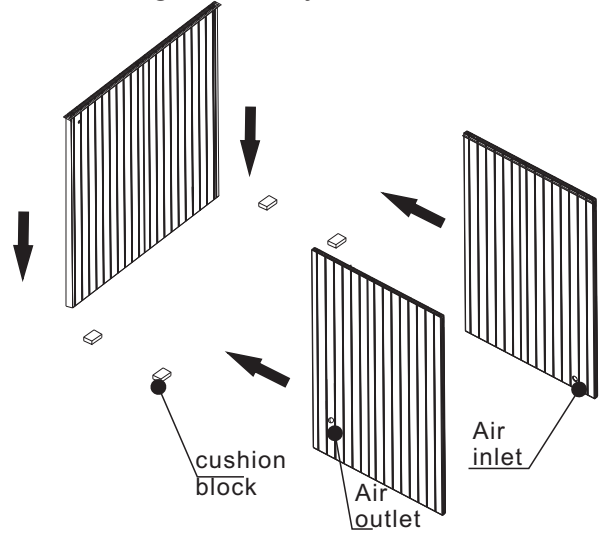

Note: After it is connected and when the installation is difficult to complete, use the glue hammer to tap for adjustment.

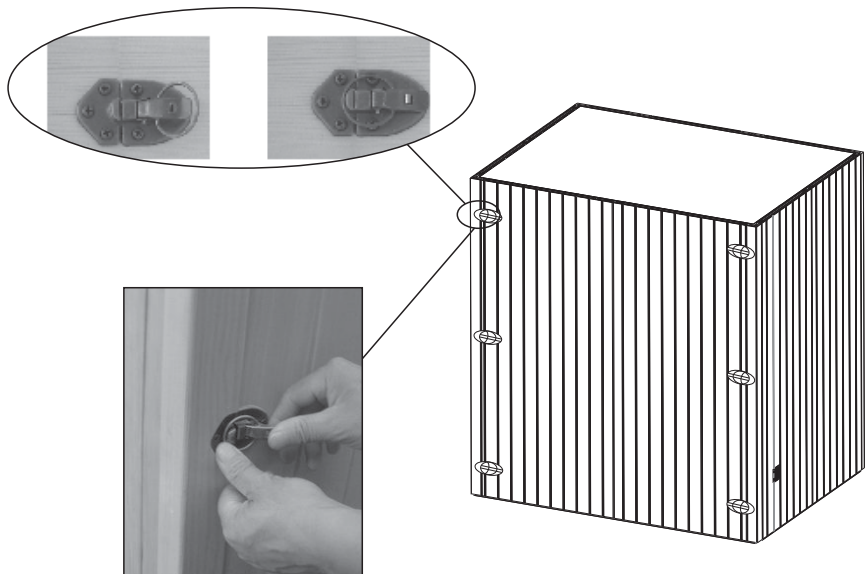

2. Front door installation

2-1: Front wall installation.

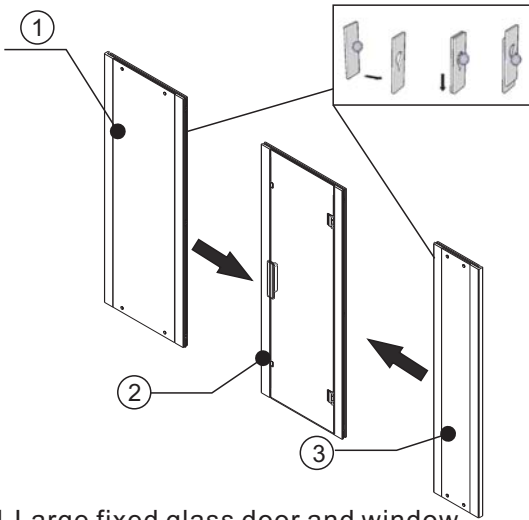

1. Large fixed glass door and window
2. switch glass door
3. Small fixed glass door and window

2-2: Install the large fixed glass door and window

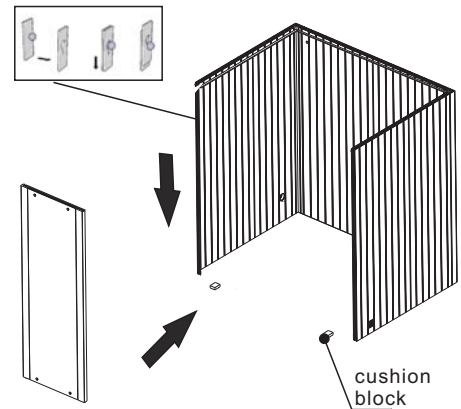

Connect and fix with the hidden catch of the glass window and on the left wall.

2-3: Install the switch door with the hidden catch below.

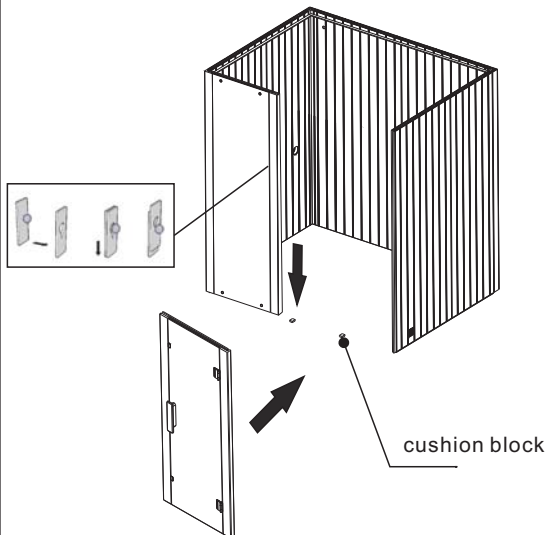

Note: After it is connected and when the installation is difficult to complete, use the glue hammer to tap for adjustment.

2-4: Install the small fixed glass door and window, making it align with the hidden catch of the fixed glass door and the right wall.

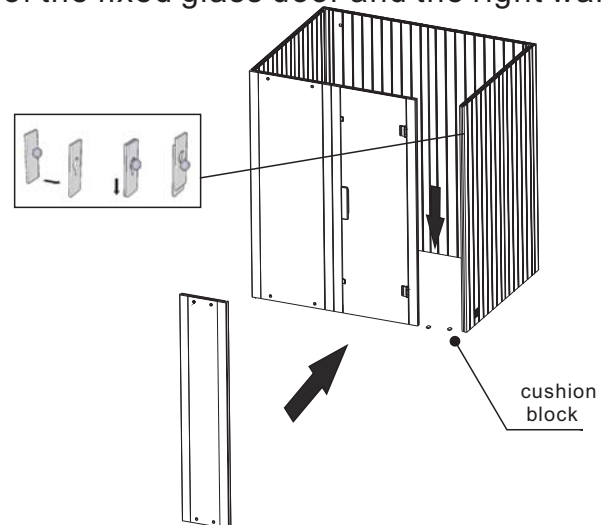

Note: After it is connected and when the installation is difficult to complete, use the glue hammer to tap for adjustment.

3. Top Panel installation

3-1: Installation figure of top cover plate

Top air outlet

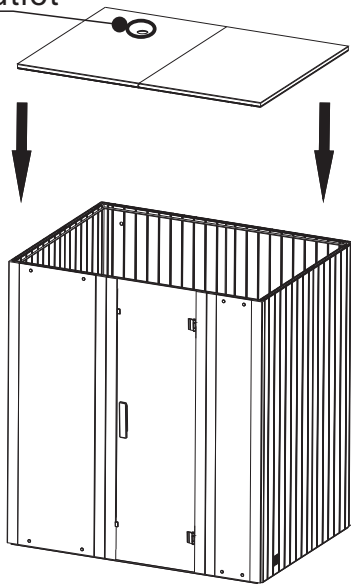

3-2: Fix the top cover plate around with screws.

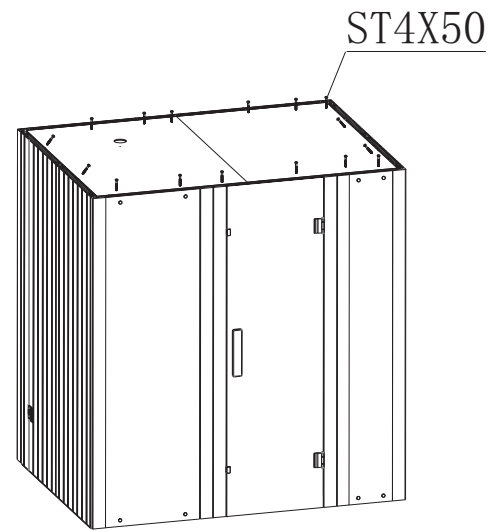

4. Bottom board installation

4-1: Installation Bottom connection bar

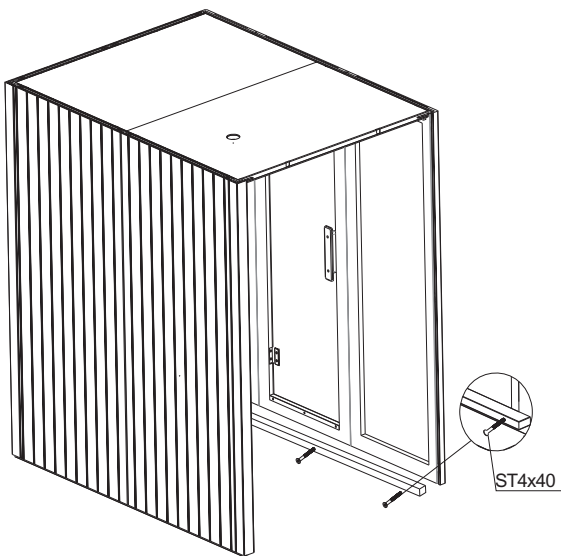

4-2: Installation bottom board.

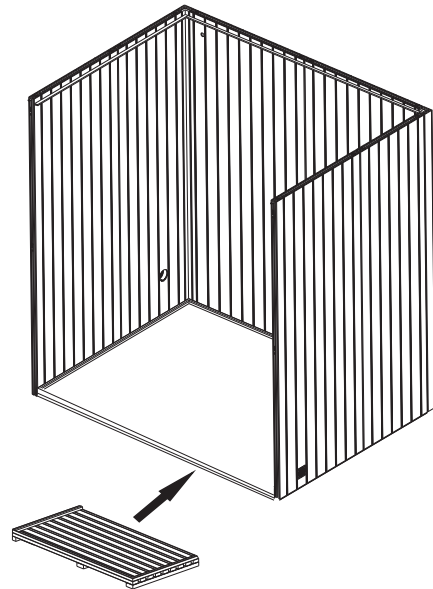

5. Bench and other accessories installation

5-1: Installation figure of bench feet

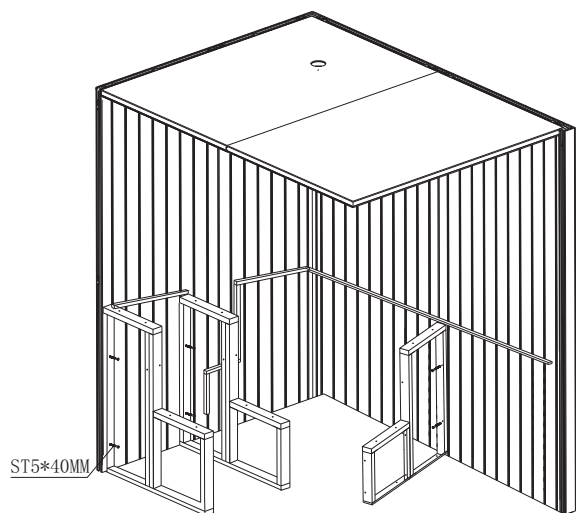

5-2: Installation figure of bench

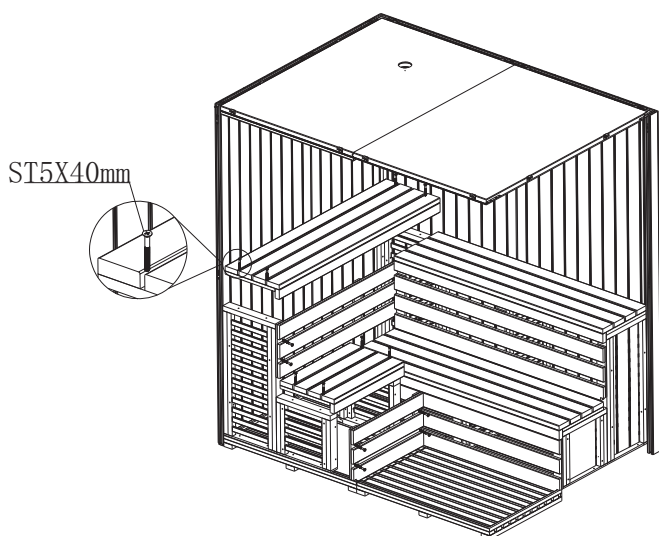
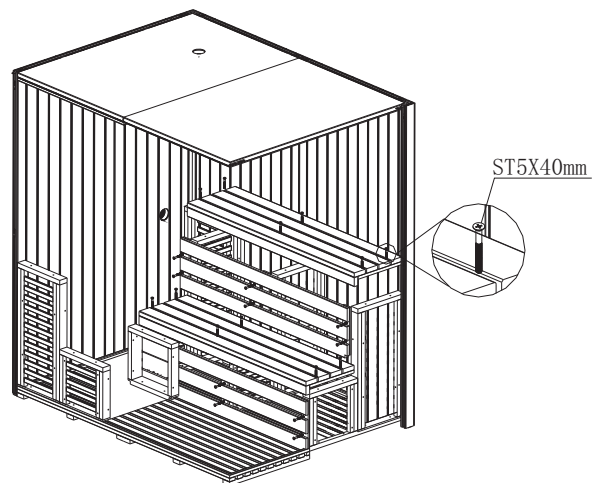

5-3: Installation figure of backrest and explosion-proof light

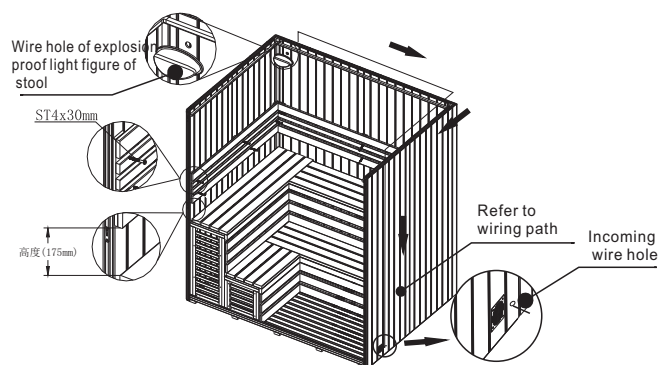

Tip: The lamp line can be led along the lamp line tube. The user can adjust the time it leads out from the bottom according to the real situation.

6、Sauna heater fence installation

6-1: Assembly figure of heater fence

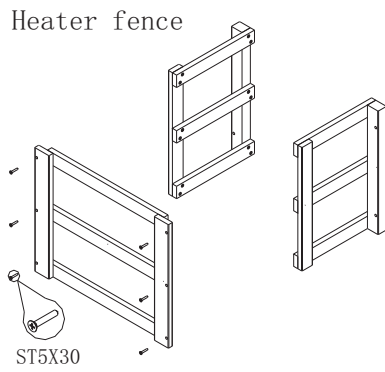

6-2: Installation figure of heater fence

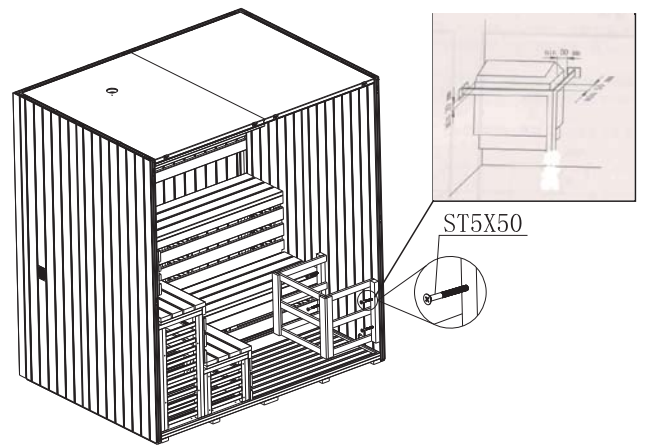

Note: When the stove is installed on the wall beyond the ground, and the fence shall be raised up with the stove. The details are shown in the above figure.

Sketch after installation

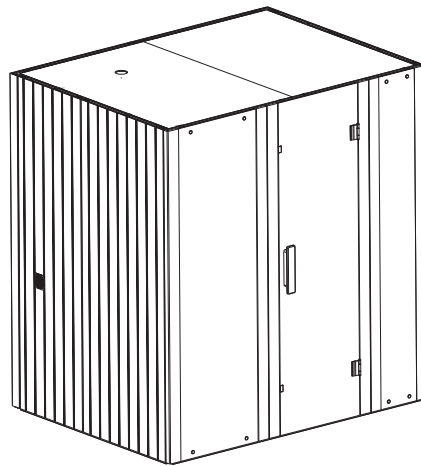

9、 Instructions on use, maintenance and attentions:

Use:

- (1) Start the sauna heater, set the constant controller at the temperature you need, turn on the switch to preheat it for 30-60 minutes, and 60°C-80°C is usually recommended (area from stool to head). For the first use, start from a lower temperature, and then adjust it according to how your body can withstand (generally speaking, it is 80-85°C for dry steaming, and can also be higher, while it is usually 45-60°C for wet steaming (in the steam room)).
- (2) The difference between “dry steaming” and “wet steaming”: "dry steaming" requires no pouring water over the heated stones to make room humidity under 10%. If you like dry steaming, you may choose some books you like to read, and enjoy good time in sauna. "Wet steaming" has higher humidity which is over 35%. Most customers prefer wet steaming, for it gives waves of steam shock to relieve fatigue, clean the skin and waste in the body, thus benefiting both the body and the spirit.
- (3) Before entering the sauna, please take off clothes, glasses, jewelries, leave mobile phones and other things outside, and then take a quick shower or bath.
- (4) It is usually 5-15 minutes each time.
- (5) After entering the sauna, you can soak in the swimming pool, wipe your body with snow, and take a shower to cool your body for 10-20 minutes.
- (6) The so called “steam shock” means pouring water over the heated stones in the sauna to generate a lot of steam and heat instantly. The steam and heat create a special environment in which the body experiences shocks, also known as “steam shock”.
- (7) If you re-enter the sauna room, you may find there are droplets on the sauna stone condensed from steam. If water overflows from the heater to the ground, it means you have used it for too many times, although it has no harm to your heater and sauna room.
- (8) After the last entry into the sauna, you should rest for at least 20 minutes. First take a shower with soap and warm water, then with cold water to close your skin pores. Put on clothes when your body temperature completely cools down. (Children must be accompanied by parents for the use of sauna)

Maintenance:

- (1) It is recommended to regularly clean up the sauna, keep it ventilated, and check whether wires for electrical appliances are aging or damaged.
- (2) It is recommended to oil-coat the sauna room every year; you can choose the wood wax coating service provided by the Company when the product leaves the factory.
- (3) It is recommended to lay a carpet at the door to keep the floor clean.
- (4) For daily maintenance, it is recommended to wipe out stubborn dirt in the sauna with sandpaper.
- (5) It is recommended to regularly replace sauna stones. Generally speaking, sauna stones need replacing after 500 hours (>500 hours) of use.

! Important:

- (1) Don't take sauna bath after excessive eating and drinking or if you cough seriously. Patients diagnosed with serious heart disease and hypertension should pay special attention for the use of sauna.
- (2) During use, don't pour water on sauna stones when any part of your body is above the sauna stones to avoid possible burn by the steam.
- (3) When there is a failure in electrical appliance, please stop using it and have it repaired by professionals.